

CMOS 21-Stage Counter

High-Voltage Types (20-Volt Rating)

■ CD4045B is a timing circuit consisting of 21 counter stages, two output-shaping flip-flops, two inverter output drivers, and input inverters for use in a crystal oscillator. The CD4045B configuration provides 21 flip-flop counting stages, and two flip-flops for shaping the output waveform for a 3.125% duty cycle. Push-pull operation is provided by the inverter output drivers.

The first inverter is intended for use as a crystal oscillator/amplifier. However, it may be used as a normal logic inverter if desired. A crystal oscillator circuit can be made less sensitive to voltage-supply variations by the use of source resistors. In this device, the sources of the p and n transistors have been brought out to package terminals. If external resistors are not required, the sources must be shorted to their respective substrates (S_p to V_{DD} , S_n to V_{SS}). See Fig. 1. The first inverter in conjunction with an outboard inverter, such as 1/6 CD4069, and R_X , C_X , and R_S can also be used to construct an RC oscillator. The following data is supplied as a guide in the selection of values for R_X , R_S , and C_X used in Fig. 11:

1. R_X max = 10 M Ω with R_S = 10 M Ω and C_X = 50 pF
2. C_X max = 25 μ F with R_S = 560 k Ω and R_X = 50 k Ω

The CD4045B types are supplied in 16-lead dual-in-line plastic packages (E suffix), 16-lead small-outline package (NSR suffix), and 16-lead thin shrink small-outline packages (PW and PWR suffixes).

Applications:

- Digital equipment in which ultra-low dissipation and/or operation using a battery source is required.
- Accurate timing from a crystal oscillator for timing applications such as wall clocks, table clocks, automobile clocks, and digital timing references in any circuit requiring accurately timed outputs at various intervals in the counting sequence.
- Driving miniature synchronous motors, stepping motors, or external bipolar transistors in push-pull fashion.

Features:

- Very low operating dissipation <1 mW (typ.) @ V_{DD} = 5 V, $f\phi$ = 1 MHz
- Output drivers with sink or source capability 7 mA (typ.) @ V_{DD} = 5 V
- Medium speed (typ.) $f\phi$ = 25 MHz @ V_{DD} = 10 V
- 100% tested for quiescent current at 20 V
- 5-V, 10-V, and 15-V parametric ratings
- Meets all requirements of JEDEC Tentative Standard No. 13B, Standard Specifications for Description of 'B' Series CMOS Devices"

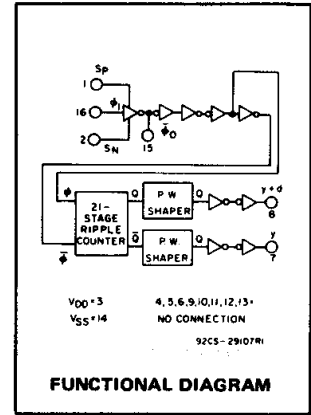

MAXIMUM RATINGS, Absolute-Maximum Values:

DC SUPPLY-VOLTAGE RANGE, (V_{DD})	-0.5V to +20V
Voltages referenced to V_{SS} Terminal	
INPUT VOLTAGE RANGE, ALL INPUTS	-0.5V to V_{DD} + 0.5V
DC INPUT CURRENT, ANY ONE INPUT	\pm 10mA
POWER DISSIPATION PER PACKAGE (P_D):	
For T_A = -55°C to +100°C	500mW
For T_A = +100°C to +125°C	Derate Linearly at 12mW/°C to 200mW
DEVICE DISSIPATION PER OUTPUT TRANSISTOR	
FOR T_A = FULL PACKAGE-TEMPERATURE RANGE (All Package Types)	100mW
OPERATING-TEMPERATURE RANGE (T_A)	-55°C to +125°C
STORAGE TEMPERATURE RANGE (T_{stg})	-85°C to +150°C
LEAD TEMPERATURE (DURING SOLDERING):	
At distance 1/16 \pm 1/32 inch (1.59 \pm 0.79mm) from case for 10s max	+265°C

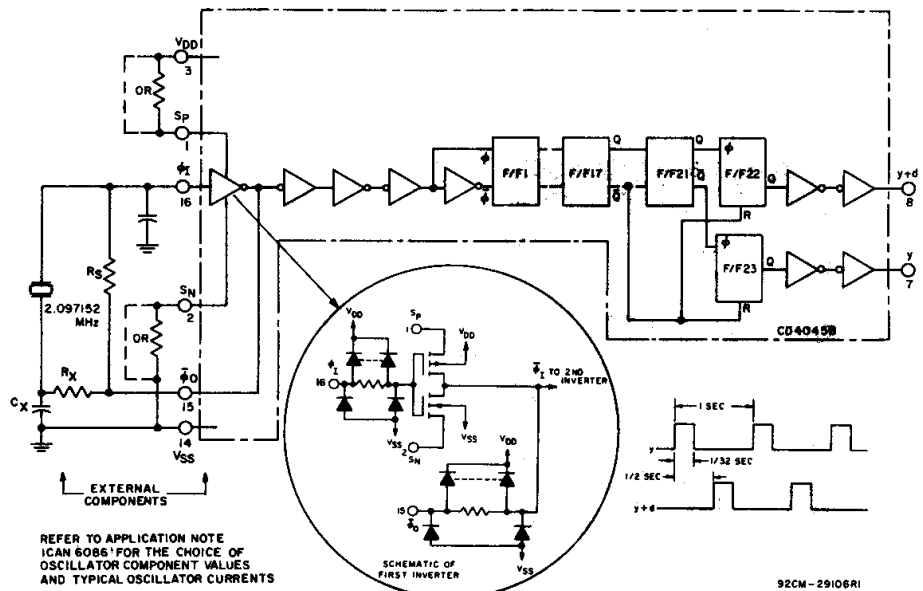

Fig. 1 - CD4045B and outboard components in a typical 21-stage counter application.

CD4045B Types

STATIC ELECTRICAL CHARACTERISTICS

CHARACTERISTIC	CONDITIONS			LIMITS AT INDICATED TEMPERATURES (°C)							UNITS
	V _O (V)	V _{IN} (V)	V _{DD} (V)	-55	-40	+85	+125	+25			
								Min.	Typ.	Max.	
Quiescent Device Current, I _{DD} Max.	—	0,5	5	5	5	150	150	—	0,04	5	μA
	—	0,10	10	10	10	300	300	—	0,04	10	
	—	0,15	15	20	20	600	600	—	0,04	20	
	—	0,20	20	100	100	3000	3000	—	0,08	100	
Output Low (Sink) Current I _{OL} Min.	0,4	0,5	5	4,5	4,3	2,9	2,5	3,6	7	—	mA
	0,5	0,10	10	11,2	10,5	7,7	6,3	9,1	18	—	
	1,5	0,15	15	29,4	28	19,6	16,8	23,8	47	—	
Output High (Source) Current, I _{OH} Min.	4,6	0,5	5	-4,5	-4,3	-2,9	-2,5	-3,6	-7	—	mA
	9,5	0,10	10	-11,2	-10,5	-7,7	-6,3	-9,1	-18	—	
	13,5	0,15	15	-29,4	-28	-19,6	-16,8	-23,8	-47	—	
Pin 15 Output Low and High Current, I _{OL} , I _{OH}	0,4,4,6	0,5	5	—				±0,1	±0,18	—	mA
	0,5,9,5	0,10	10	—				±0,2	±0,3	—	
	1,5,13,5	0,15	15	—				±0,5	±1	—	
Output Voltage: Low-Level, V _{OL} Max.	—	0,5	5	0,05				—	—	0,05	V
	—	0,10	10	0,05				—	—	0,05	
	—	0,15	15	0,05				—	—	0,05	
Output Voltage: High-Level, V _{OH} Min.	—	0,5	5	4,95				4,95	5	—	V
	—	0,10	10	9,95				9,95	10	—	
	—	0,15	15	14,95				14,95	15	—	
Input Low Voltage V _{IL} Max.	0,5,4,5	—	5	1,5				—	—	1,5	V
	1,9	—	10	3				—	—	3	
	1,5,13,5	—	15	4				—	—	4	
Input High Voltage, V _{IH} Min.	0,5,4,5	—	5	3,5				3,5	—	—	V
	1,9	—	10	7				7	—	—	
	1,5,13,5	—	15	11				11	—	—	
Input Current I _{IN} Max.	—	0,18	18	±0,1	±0,1	±1	±1	—	±10 ⁻⁵	±0,1	μA

RECOMMENDED OPERATING CONDITIONS

For maximum reliability, nominal operating conditions should be selected so that operation is always within the following ranges

CHARACTERISTIC	V _{DD} (V)	LIMITS		UNITS
		Min.	Max.	
Supply-Voltage Range (For T _A = Full Package-Temperature Range)	—	3	18	V
Minimum Input-Pulse Width, t _w	5	—	100	ns
	10	—	50	
	15	—	40	
Maximum Input-Pulse Frequency, f _φ (External Pulse Source)	5	5	—	MHz
	10	12	—	
	15	15	—	

3
COMMERCIAL CMOS
HIGH VOLTAGE ICs

CD4045B Types

DYNAMIC ELECTRICAL CHARACTERISTICS at $T_A = 25^\circ\text{C}$; Input $t_r, t_f = 20\text{ ns}$, $C_L = 50\text{ pF}$, $R_L = 200\text{ k}\Omega$

CHARACTERISTIC	TEST CONDITIONS	V_{DD} V	LIMITS			UNITS
			Min.	Typ.	Max.	
Propagation Delay Time: ϕ_1 to y or y+d out t_{PHL}, t_{PLH}		5	—	2.2	5.5	μs
		10	—	0.9	2.7	
		15	—	0.65	2	
Transition Time: t_{THL}, t_{TLH}		5	—	25	50	ns
		10	—	13	25	
		15	—	10	20	
Minimum Input-Pulse Width t_W		5	—	50	100	ns
		10	—	25	50	
		15	—	20	40	
Input-Pulse Rise or Fall Time: $t_r\phi, t_f\phi$		5	—	—	500	μs
		10	—	—	500	
		15	—	—	500	
Maximum Input-Pulse Frequency: (External Pulse Source) f_ϕ		5	5	10	—	MHz
		10	12	25	—	
		15	15	30	—	
Input Capacitance, C_{IN}	Any Input		—	5	7.5	pF
Variation of Output Frequency (Unit-to-Unit)	$f = 5\text{ MHz}$	5	—	0.05	—	%
		10	—	0.03	—	
		15	—	0.1	—	
RC Oscillator Operation						
Maximum Oscillator Frequency (See Fig. 11) f_{osc}	$R_X = 50\text{ k}\Omega$, $R_S = 560\text{ k}\Omega$, $C_X = 50\text{ pF}$	5	45	60	75	kHz
		10	45	60	75	
		15	45	60	75	

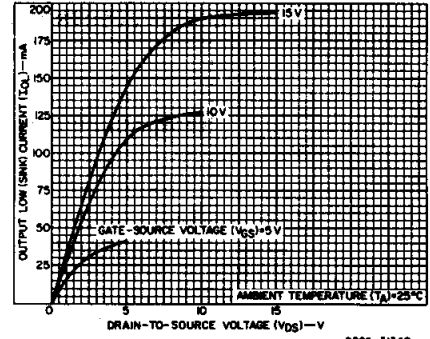

Fig. 2 — Typical output low (sink) current characteristics.

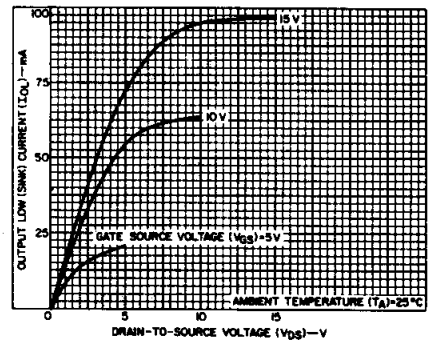

Fig. 3 — Minimum output low (sink) current characteristics.

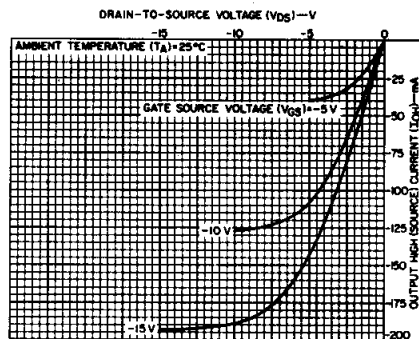

Fig. 4 — Typical output high (source) current characteristics.

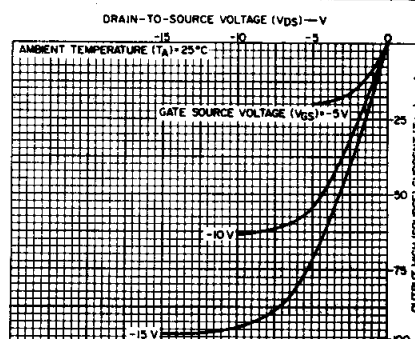

Fig. 5 — Minimum output high (source) current characteristics.

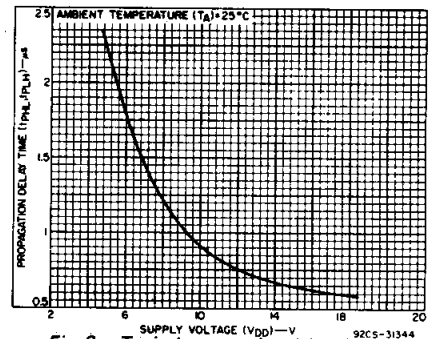

Fig. 6 — Typical propagation delay time as a function of supply voltage (ϕ_1 to y or y + d out vs. V_{DD}).

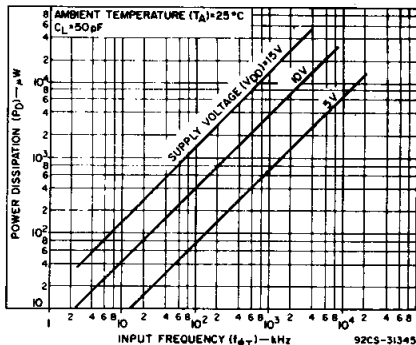

Fig. 7 — Typical power dissipation as a function of input frequency (21 counting stages).

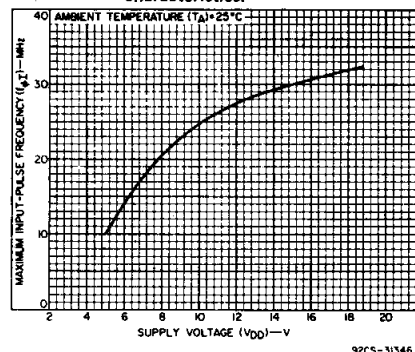

Fig. 8 — Typical maximum input-pulse frequency as a function of supply voltage.

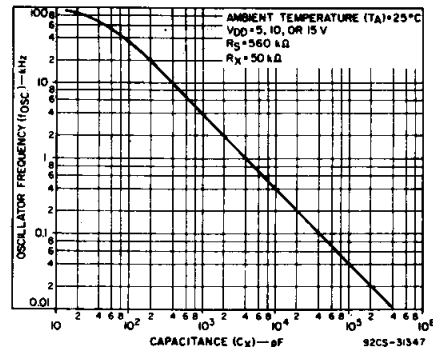

Fig. 9 — Typical RC oscillator frequency as a function of capacitance (C_X), See Fig. 11.

CD4045B Types

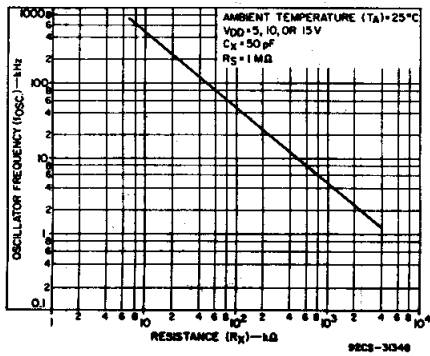

Fig. 10 – Typical RC oscillator frequency as a function of resistance (R_X). See Fig. 11.

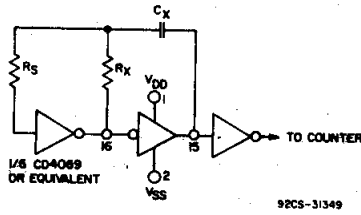

Fig. 11 – Typical RC circuit.

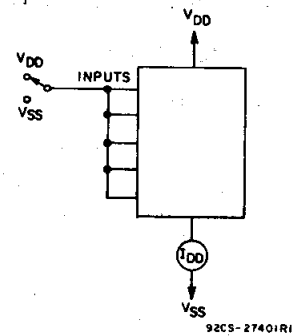

Fig. 12 – Quiescent device current test circuit.

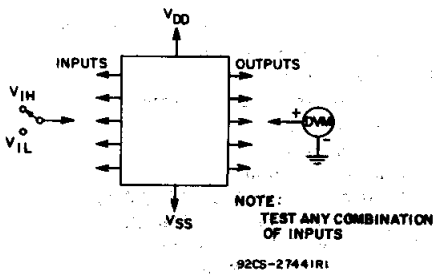

Fig. 13 – Noise immunity test circuit.

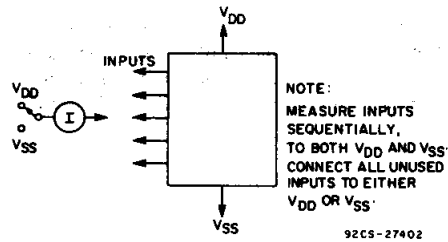

Fig. 14 – Input leakage current test circuit.

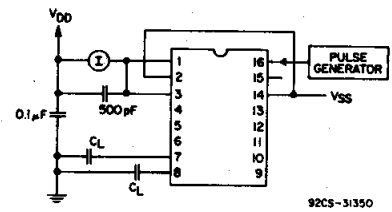
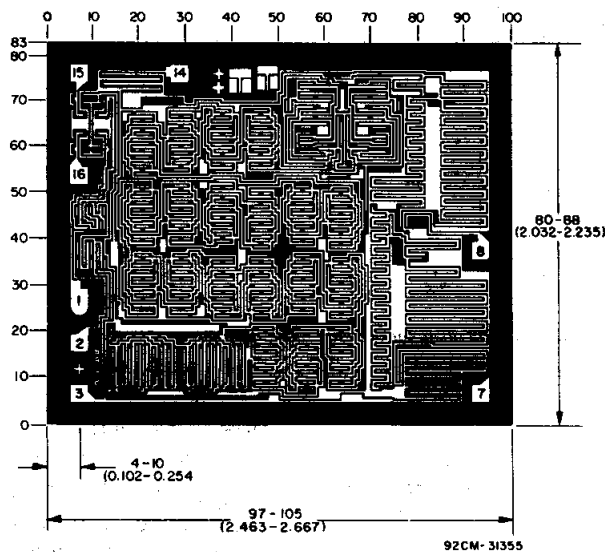

Fig. 15 – Dynamic power dissipation test circuit.



Chip dimensions and pad layout for CD4045B

Dimensions in parentheses are in millimeters and are derived from the basic inch dimensions as indicated. Grid graduations are in mils (10^{-3} inch).

TERMINAL DIAGRAM Top View

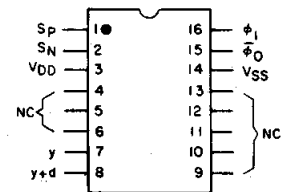

NC = NO CONNECTION

NOTE Observe power-supply terminal connections, V_{DD} is terminal No. 3 and V_{SS} is terminal No. 14 (not 16 and 8 respectively, as in other CD4000B Series 16-lead devices).

3
COMMERCIAL CMOS
HIGH VOLTAGE ICs

PACKAGING INFORMATION

Orderable Device	Status ⁽¹⁾	Package Type	Package Drawing	Pins	Package Qty	Eco Plan ⁽²⁾	Lead/Ball Finish	MSL Peak Temp ⁽³⁾
CD4045BE	ACTIVE	PDIP	N	16	25	Pb-Free (RoHS)	CU NIPDAU	N / A for Pkg Type
CD4045BEE4	ACTIVE	PDIP	N	16	25	Pb-Free (RoHS)	CU NIPDAU	N / A for Pkg Type
CD4045BNSR	ACTIVE	SO	NS	16	2000	Green (RoHS & no Sb/Br)	CU NIPDAU	Level-1-260C-UNLIM
CD4045BNSRE4	ACTIVE	SO	NS	16	2000	Green (RoHS & no Sb/Br)	CU NIPDAU	Level-1-260C-UNLIM
CD4045BNSRG4	ACTIVE	SO	NS	16	2000	Green (RoHS & no Sb/Br)	CU NIPDAU	Level-1-260C-UNLIM
CD4045BPW	ACTIVE	TSSOP	PW	16	90	Green (RoHS & no Sb/Br)	CU NIPDAU	Level-1-260C-UNLIM
CD4045BPWE4	ACTIVE	TSSOP	PW	16	90	Green (RoHS & no Sb/Br)	CU NIPDAU	Level-1-260C-UNLIM
CD4045BPWG4	ACTIVE	TSSOP	PW	16	90	Green (RoHS & no Sb/Br)	CU NIPDAU	Level-1-260C-UNLIM
CD4045BPWR	ACTIVE	TSSOP	PW	16	2000	Green (RoHS & no Sb/Br)	CU NIPDAU	Level-1-260C-UNLIM
CD4045BPWRE4	ACTIVE	TSSOP	PW	16	2000	Green (RoHS & no Sb/Br)	CU NIPDAU	Level-1-260C-UNLIM
CD4045BPWRG4	ACTIVE	TSSOP	PW	16	2000	Green (RoHS & no Sb/Br)	CU NIPDAU	Level-1-260C-UNLIM

⁽¹⁾ The marketing status values are defined as follows:

ACTIVE: Product device recommended for new designs.

LIFEBUY: TI has announced that the device will be discontinued, and a lifetime-buy period is in effect.

NRND: Not recommended for new designs. Device is in production to support existing customers, but TI does not recommend using this part in a new design.

PREVIEW: Device has been announced but is not in production. Samples may or may not be available.

OBSOLETE: TI has discontinued the production of the device.

⁽²⁾ Eco Plan - The planned eco-friendly classification: Pb-Free (RoHS), Pb-Free (RoHS Exempt), or Green (RoHS & no Sb/Br) - please check <http://www.ti.com/productcontent> for the latest availability information and additional product content details.

TBD: The Pb-Free/Green conversion plan has not been defined.

Pb-Free (RoHS): TI's terms "Lead-Free" or "Pb-Free" mean semiconductor products that are compatible with the current RoHS requirements for all 6 substances, including the requirement that lead not exceed 0.1% by weight in homogeneous materials. Where designed to be soldered at high temperatures, TI Pb-Free products are suitable for use in specified lead-free processes.

Pb-Free (RoHS Exempt): This component has a RoHS exemption for either 1) lead-based flip-chip solder bumps used between the die and package, or 2) lead-based die adhesive used between the die and leadframe. The component is otherwise considered Pb-Free (RoHS compatible) as defined above.

Green (RoHS & no Sb/Br): TI defines "Green" to mean Pb-Free (RoHS compatible), and free of Bromine (Br) and Antimony (Sb) based flame retardants (Br or Sb do not exceed 0.1% by weight in homogeneous material)

⁽³⁾ MSL, Peak Temp. -- The Moisture Sensitivity Level rating according to the JEDEC industry standard classifications, and peak solder temperature.

Important Information and Disclaimer:The information provided on this page represents TI's knowledge and belief as of the date that it is provided. TI bases its knowledge and belief on information provided by third parties, and makes no representation or warranty as to the accuracy of such information. Efforts are underway to better integrate information from third parties. TI has taken and continues to take reasonable steps to provide representative and accurate information but may not have conducted destructive testing or chemical analysis on incoming materials and chemicals. TI and TI suppliers consider certain information to be proprietary, and thus CAS numbers and other limited information may not be available for release.

In no event shall TI's liability arising out of such information exceed the total purchase price of the TI part(s) at issue in this document sold by TI

to Customer on an annual basis.

TAPE AND REEL INFORMATION

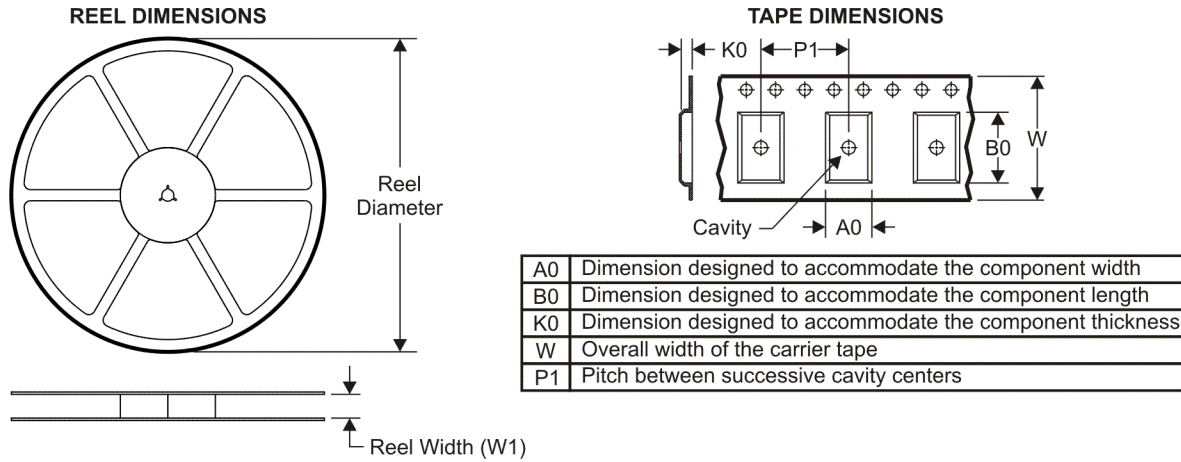

QUADRANT ASSIGNMENTS FOR PIN 1 ORIENTATION IN TAPE



*All dimensions are nominal

Device	Package Type	Package Drawing	Pins	SPQ	Reel Diameter (mm)	Reel Width W1 (mm)	A0 (mm)	B0 (mm)	K0 (mm)	P1 (mm)	W (mm)	Pin1 Quadrant
CD4045BNSR	SO	NS	16	2000	330.0	16.4	8.2	10.5	2.5	12.0	16.0	Q1
CD4045BPWR	TSSOP	PW	16	2000	330.0	12.4	7.0	5.6	1.6	8.0	12.0	Q1

TAPE AND REEL BOX DIMENSIONS



*All dimensions are nominal

Device	Package Type	Package Drawing	Pins	SPQ	Length (mm)	Width (mm)	Height (mm)
CD4045BNSR	SO	NS	16	2000	346.0	346.0	33.0
CD4045BPWR	TSSOP	PW	16	2000	346.0	346.0	29.0

PW (R-PDSO-G**)

PLASTIC SMALL-OUTLINE PACKAGE

14 PINS SHOWN



4040064/F 01/97

- NOTES: A. All linear dimensions are in millimeters.
 B. This drawing is subject to change without notice.
 C. Body dimensions do not include mold flash or protrusion not to exceed 0,15.
 D. Falls within JEDEC MO-153

MECHANICAL DATA

NS (R-PDSO-G**)

PLASTIC SMALL-OUTLINE PACKAGE

14-PINS SHOWN



- NOTES:
- A. All linear dimensions are in millimeters.
 - B. This drawing is subject to change without notice.
 - C. Body dimensions do not include mold flash or protrusion, not to exceed 0,15.

N (R-PDIP-T**)

PLASTIC DUAL-IN-LINE PACKAGE

16 PINS SHOWN



- NOTES:
- A. All linear dimensions are in inches (millimeters).
 - B. This drawing is subject to change without notice.
 - $\triangle C$ Falls within JEDEC MS-001, except 18 and 20 pin minimum body length (Dim A).
 - $\triangle D$ The 20 pin end lead shoulder width is a vendor option, either half or full width.

4040049/E 12/2002

IMPORTANT NOTICE

Texas Instruments Incorporated and its subsidiaries (TI) reserve the right to make corrections, modifications, enhancements, improvements, and other changes to its products and services at any time and to discontinue any product or service without notice. Customers should obtain the latest relevant information before placing orders and should verify that such information is current and complete. All products are sold subject to TI's terms and conditions of sale supplied at the time of order acknowledgment.

TI warrants performance of its hardware products to the specifications applicable at the time of sale in accordance with TI's standard warranty. Testing and other quality control techniques are used to the extent TI deems necessary to support this warranty. Except where mandated by government requirements, testing of all parameters of each product is not necessarily performed.

TI assumes no liability for applications assistance or customer product design. Customers are responsible for their products and applications using TI components. To minimize the risks associated with customer products and applications, customers should provide adequate design and operating safeguards.

TI does not warrant or represent that any license, either express or implied, is granted under any TI patent right, copyright, mask work right, or other TI intellectual property right relating to any combination, machine, or process in which TI products or services are used. Information published by TI regarding third-party products or services does not constitute a license from TI to use such products or services or a warranty or endorsement thereof. Use of such information may require a license from a third party under the patents or other intellectual property of the third party, or a license from TI under the patents or other intellectual property of TI.

Reproduction of TI information in TI data books or data sheets is permissible only if reproduction is without alteration and is accompanied by all associated warranties, conditions, limitations, and notices. Reproduction of this information with alteration is an unfair and deceptive business practice. TI is not responsible or liable for such altered documentation. Information of third parties may be subject to additional restrictions.

Resale of TI products or services with statements different from or beyond the parameters stated by TI for that product or service voids all express and any implied warranties for the associated TI product or service and is an unfair and deceptive business practice. TI is not responsible or liable for any such statements.

TI products are not authorized for use in safety-critical applications (such as life support) where a failure of the TI product would reasonably be expected to cause severe personal injury or death, unless officers of the parties have executed an agreement specifically governing such use. Buyers represent that they have all necessary expertise in the safety and regulatory ramifications of their applications, and acknowledge and agree that they are solely responsible for all legal, regulatory and safety-related requirements concerning their products and any use of TI products in such safety-critical applications, notwithstanding any applications-related information or support that may be provided by TI. Further, Buyers must fully indemnify TI and its representatives against any damages arising out of the use of TI products in such safety-critical applications.

TI products are neither designed nor intended for use in military/aerospace applications or environments unless the TI products are specifically designated by TI as military-grade or "enhanced plastic." Only products designated by TI as military-grade meet military specifications. Buyers acknowledge and agree that any such use of TI products which TI has not designated as military-grade is solely at the Buyer's risk, and that they are solely responsible for compliance with all legal and regulatory requirements in connection with such use.

TI products are neither designed nor intended for use in automotive applications or environments unless the specific TI products are designated by TI as compliant with ISO/TS 16949 requirements. Buyers acknowledge and agree that, if they use any non-designated products in automotive applications, TI will not be responsible for any failure to meet such requirements.

Following are URLs where you can obtain information on other Texas Instruments products and application solutions:

Products

Amplifiers	amplifier.ti.com
Data Converters	dataconverter.ti.com
DSP	dsp.ti.com
Clocks and Timers	www.ti.com/clocks
Interface	interface.ti.com
Logic	logic.ti.com
Power Mgmt	power.ti.com
Microcontrollers	microcontroller.ti.com
RFID	www.ti-rfid.com
RF/IF and ZigBee® Solutions	www.ti.com/lprf

Applications

Audio	www.ti.com/audio
Automotive	www.ti.com/automotive
Broadband	www.ti.com/broadband
Digital Control	www.ti.com/digitalcontrol
Medical	www.ti.com/medical
Military	www.ti.com/military
Optical Networking	www.ti.com/opticalnetwork
Security	www.ti.com/security
Telephony	www.ti.com/telephony
Video & Imaging	www.ti.com/video
Wireless	www.ti.com/wireless

Mailing Address: Texas Instruments, Post Office Box 655303, Dallas, Texas 75265
Copyright © 2008, Texas Instruments Incorporated